

TORROS

Fakenham Industrial Estate, 1 Wymans Way, Fakenham NR21 8NT
T: +44 (0)1328 862 700
www.torros.net

Drum Handling RFQ

Company: _____

Contact: _____

Project Ref _____

Pick Up Data

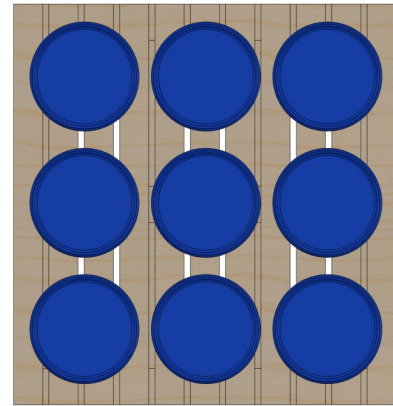
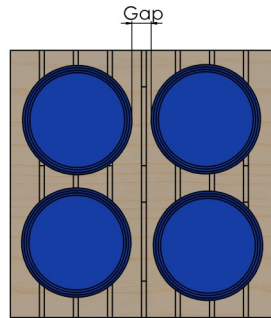
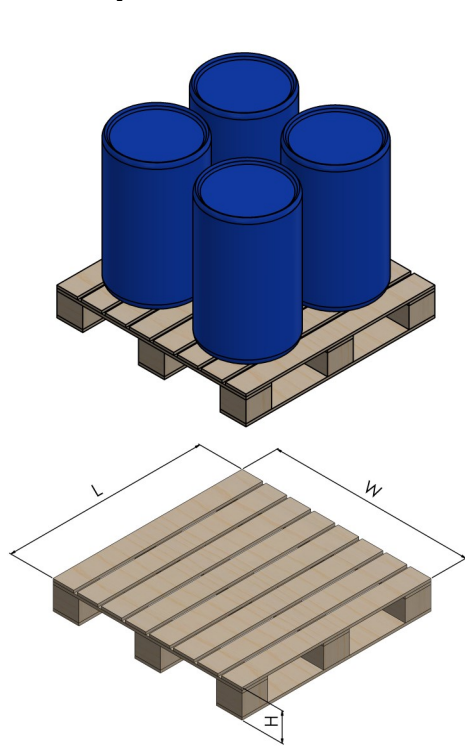

Euro Pallet ?
Closed Pallet on 4 sides?

Unload Data

Forward pour?
Side pour?
Water environment?
Lift only?
Power tip?

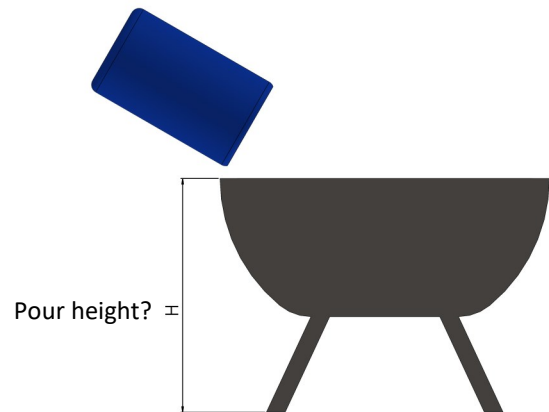

Drum type

Ribbed?
Steel ?

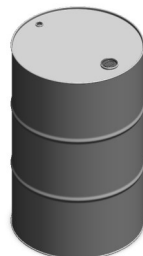

Plastic?
Fiber?

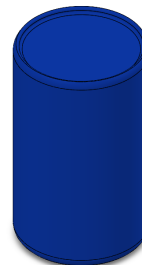

Diameter min/max _____

Height min/max _____

Weight kg _____

Method

Lip Grip?

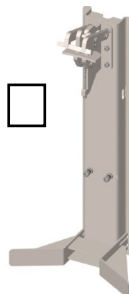

Band clamp?

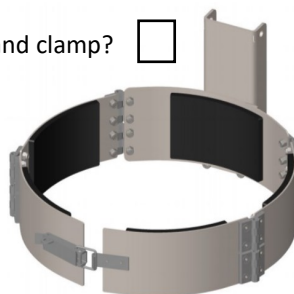

Moving arms?

